

JY997D17401H



MITSUBISHI *Changes for the Better*

GT1155-QTBD, GT1155-QSBD, GT1150-QLBD

GT11 General Description

Manual Number	JY997D17401H
Date	Jul. 2008

GRAPHIC OPERATION TERMINAL
GOT1000

This manual describes the part names, dimensions, mounting, and specifications of the product. Before use, read this manual and manuals of relevant products fully to acquire proficiency in handling and operating the product. Make sure to learn all the product information, safety information, and precautions.
And, store this manual in a safe place so that you can take it out and read it whenever necessary. Always forward it to the end user.
Registration
The company name and the product name to be described in this manual are the registered trademarks or trademarks of each company.



Effective May 2008
Specifications are subject to change without notice.

© 2008 Mitsubishi Electric Corporation

Safety Precaution (Read these precautions before using.)

Before using this product, please read this manual and the relevant manuals introduced in this manual carefully and pay full attention to safety to handle the product correctly.

The precautions given in this manual are concerned with this product. In this manual, the safety precautions are ranked as "DANGER" and "CAUTION".

	Indicates that incorrect handling may cause hazardous conditions, resulting in death or severe injury.
	Indicates that incorrect handling may cause hazardous conditions, resulting in medium or slight personal injury or physical damage.

Depending on circumstances, procedures indicated by "CAUTION" may also be linked to serious results.

In any case, it is important to follow the directions for usage.

DESIGN PRECAUTIONS

- Some failures of the GOT or cable may keep the outputs on or off. An external monitoring circuit should be provided to check for output signals which may lead to a serious accident.
Not doing so can cause an accident due to false output or malfunction.
- If a communication fault (including cable disconnection) occurs during monitoring on the GOT, communication between the GOT and PLC CPU is suspended and the GOT becomes inoperative.
A system where the GOT is used should be configured to perform any significant operation to the system by using the switches of a device other than the GOT on the assumption that a GOT communication fault will occur.
Not doing so can cause an accident due to false output or malfunction.
- Do not use the GOT as the warning device that may cause a serious accident.
An independent and redundant hardware or mechanical interlock is required to configure the device that displays and outputs serious warning.
Failure to observe this instruction may result in an accident due to incorrect output or malfunction.
- Incorrect operation of the touch switch(s) may lead to a serious accident if the GOT backlight is gone out.
When the GOT backlight goes out, the POWER LED flickers (green/orange) and the display section turns black and causes the monitor screen to appear blank, while the input of the touch switch(s) remains active.
This may confuse an operator in thinking that the GOT is in "screensaver" mode, who then tries to release the GOT from this mode by touching the display section, which may cause a touch switch to operate.
Note that the following occurs on the GOT when the backlight goes out.
 - The POWER LED flickers (green/orange) and the monitor screen appears blank

DESIGN PRECAUTIONS

- Do not bundle the control and communication cables with main-circuit, power or other wiring.
Run the above cables separately from such wiring and keep them a minimum of 100mm (3.94in.) apart. Not doing so noise can cause a malfunction.

MOUNTING PRECAUTIONS

- Be sure to shut off all phases of the external power supply used by the system before mounting or removing the GOT to/from the panel.
Not doing so can cause the unit to fail or malfunction.
- When installing the battery, or operating the reset switch, wear an earth band etc. to avoid the static electricity.
The static electricity can cause the unit to fail or malfunction.

MOUNTING PRECAUTIONS

- Use the GOT in the environment that satisfies the general specifications described in this manual. Not doing so can cause an electric shock, fire, malfunction or product damage or deterioration.
- When mounting the GOT to the control panel, tighten the mounting screws in the specified torque range. Undertightening can cause the GOT to drop, short circuit or malfunction. Overtightening can cause a drop, short circuit or malfunction due to the damage of the screws or the GOT.
- When inserting/removing a CF card into/from the GOT, turn the CF card access switch off in advance. Failure to do so may corrupt data within the CF card.
- When inserting a CF card into the GOT, push it into the insertion slot until the CF card eject button will pop out. Failure to do so may cause a malfunction due to poor contact.
- When removing a CF card from the GOT, make sure to support the CF card by hand, as it may pop out. Failure to do so may cause the CF card to drop from the GOT and break.

WIRING PRECAUTIONS

- Be sure to shut off all phases of the external power supply used by the system before wiring. Failure to do so may result in an electric shock, product damage or malfunctions.
- Please make sure to ground FG terminal of the GOT power supply section by applying 100 or less which is used exclusively for the GOT. Not doing so may cause an electric shock or malfunction.
- Correctly wire the GOT power supply section after confirming the rated voltage and terminal arrangement of the product. Not doing so can cause a fire or failure.
- Tighten the terminal screws of the GOT power supply section in the specified torque range. Undertightening can cause a short circuit or malfunction. Overtightening can cause a short circuit or malfunction due to the damage of the screws or the GOT.
- Exercise care to avoid foreign matter such as chips and wire offcuts entering the GOT. Not doing so can cause a fire, failure or malfunction.

WIRING PRECAUTIONS

- Plug the communication cable into the connector of the connected unit and tighten the mounting and terminal screws in the specified torque range.
Undertightening can cause a short circuit or malfunction. Overtightening can cause a short circuit or malfunction due to the damage of the screws or unit.

TEST OPERATION PRECAUTIONS

- Before performing the test operations of the user creation monitor screen (such as turning ON or OFF bit device, changing the word device current value, changing the settings or current values of the timer or counter, and changing the buffer memory current value), read through the manual carefully and make yourself familiar with the operation method.
During test operation, never change the data of the devices which are used to perform significant operation for the system. False output or malfunction can cause an accident.

STARTUP/MAINTENANCE PRECAUTIONS

- When power is on, do not touch the terminals.
Doing so can cause an electric shock or malfunction.
- Connect the battery correctly. Do not discharge, disassemble, heat, short, solder or throw the battery into the fire. Incorrect handling may cause the battery to generate heat, burst or take fire, resulting in injuries or fires.
- Before starting cleaning or terminal screw retightening, always switch off the power externally in all phases. Not switching the power off in all phases can cause a unit failure or malfunction. Undertightening can cause a short circuit or malfunction. Overtightening can cause a short circuit or malfunction due to the damage of the screws or unit.

STARTUP/MAINTENANCE PRECAUTIONS

- Do not disassemble or modify the unit.
Doing so can cause a failure, malfunction, injury or fire.
- Do not touch the conductive and electronic parts of the unit directly.
Doing so can cause a unit malfunction or failure.
- The cables connected to the unit must be run in ducts or clamped.
Not doing so can cause the unit or cable to be damaged due to the dangling, motion or accidental pulling of the cables or can cause a malfunction due to a cable connection fault.
- When unplugging the cable connected to the unit, do not hold and pull the cable portion. Doing so can cause the unit or cable to be damaged or can cause a malfunction due to a cable connection fault.
- Do not drop or apply any impact to the battery. If any impact has been applied, discard the battery and never use it.
The battery may be damaged by the drop or impact.
- Before touching the unit, always touch grounded metal, etc. to discharge static electricity from human body, etc.
Not doing so can cause the unit to fail or malfunction.

DISPOSAL PRECAUTIONS

- When disposing of the product, handle it as industrial waste.

TRANSPORTATION PRECAUTIONS

- When transporting lithium batteries, make sure to treat them based on the transport regulations.
- Before transporting the GOT, turn the GOT power on and check that the battery voltage status is normal on the Time setting & display screen (utilities screen). In addition, confirm that the adequate battery life remains on the rating plate.
Transporting the GOT with the low battery voltage or the battery the reached battery life may destabilize the backup data unstable during transportation.
- Make sure to transport the GOT main unit and/or relevant unit(s) in the manner they will not be exposed to the impact exceeding the impact resistance described in the general specifications of this manual, as they are precision devices. Failure to do so may cause the unit to fail.
Check if the unit operates correctly after transportation.

Associated Manuals

The following manuals are relevant to this product. When these loose manuals are required, please consult with our local distributor.

Manual name	Contents	Manual Number (Model Code)
GOT1000 Series Extended/Option Function Manual (sold separately) *1	Describes extended functions and option functions applicable to GOT1000 series.	SH-080544ENG (1D7M32)
GOT1000 Series Connection Manual 1/3, 2/3, 3/3 (sold separately) *1	Describes system configurations of the connection method applicable to GOT1000 series and cable creation method	SH-080532ENG (1D7M26)
GT Designer2 Version2 Basic Operation/Data Transfer Manual (For GOT1000 Series) (sold separately) *1	Describes methods of the GT Designer2 installation operation, basic operation for drawing and transmitting data to GOT1000 series	SH-080529ENG (1D7M24)
GT Designer2 Version2 Screen Design Manual (For GOT1000 Series) 1/3, 2/3, 3/3 (sold separately) *1	Describes specifications and settings of the object functions used in GT Designer2	SH-080530ENG (1D7M25)

*1 Stored in the GT Works 2/GT Designer2 in PDF format.

For details of a PLC to be connected, refer to the PLC user's manual respectively.

Bundled Items

Product Name	Model Name	Specifications		
GOT	GT1155-QTBD	5.7" diagonal [320 x 240 dots], TFT color LCD (256 colors), built-in battery and backlight		
	GT1155-QSBD	5.7" diagonal [320 x 240 dots], STN color LCD (256 colors), built-in battery and backlight		
	GT1150-QLBD	5.7" diagonal [320 x 240 dots], STN monochrome LCD (black/white, 16 scales), built-in battery and backlight		
Bundled item		Quantity	Bundled item	Quantity
Mounting brackets		4	Dust-/Water-proof packing	1
Mounting screws: M4 x 35mm (1.38")		4	GT11 General Description (This manual)	1

1. Features

- Improved monitoring performance and connectivity to FA devices
 - Multiple languages are displayed using the Unicode2.1-compatible fonts and beautiful characters are drawn using the TrueType and high quality fonts.
 - Two types of display modes are provided: 256-color display and monochrome display.
In the monochrome display, 16 scales are used to improve the display.
 - High-speed monitoring through high-speed serial communication at maximum rate of 115.2 kbps or through bus connection with the PLC.
 - High speed display and high speed touch response.
- More efficient GOT operations including screen design, startup, adjustment, management and maintenance works
 - The 3MB user memory is included as standard.
 - CF card interface is included as standard.
 - The USB connector is positioned on the GOT front. This enables the system startup to be performed more efficiently using FA device setup tool, and eliminates the indirect works (opening and closing the control panel, cable replacement, cable rewiring) in order to improve the working efficiency.
- Enhanced support of FA setup tools
 - PLC program transfer and monitoring are possible via the personal computer that is connected to the GOT if connected directly to the A, QnA, Q, or FX series of the PLC CPU (FA transparent function).

2. Part Name

2.1 Front Panel

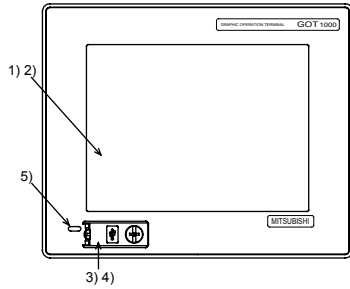

No	Name	Specifications
1)	Display screen	Displays the utility screen and the user creation screen. GT1155-QTBD:320×240 dots, TFT color liquid crystal GT1155-QSBD:320×240 dots, STN color liquid crystal GT1150-QLBD:320×240 dots, STN monochrome (white/black) liquid crystal, 16 scales
2)	Touch key	For operating the touch switches in the utility screen and the user creation screen
3)	USB interface	USB interface for connecting a personal computer (OS installation, project data download, transparent)
4)	USB environmental protection cover	Opens/Closes when the UBS interface is used.
5)	POWER LED	Lit in green : Power is correctly supplied Lit in orange : Screen saving Blinking in orange/green : Blown backlight bulb Not lit : Power is not supplied

For the PC connection, refer to the following.

→ **GT Designer2 Version □ Basic Operation/Data Transfer Manual**

2.2 Back Panel

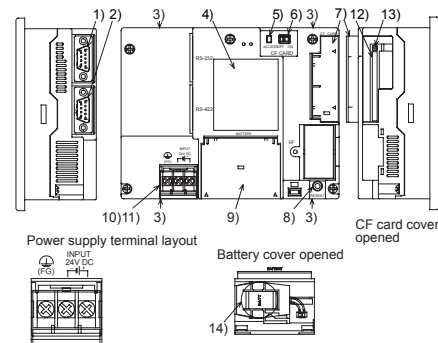

No.	Name	Specifications
1)	RS-232 interface	For communicating with controller (PLC, microcomputer board, bar code reader, RFID, etc) or personal computer (OS installation, project data download, transparent) (D-sub 9-pin male)
2)	RS-422 interface	For communicating with controller (PLC, microcomputer board, etc) (D-sub 9-pin female)
3)	Hole for unit installation fitting	Hole for the inserting installation fittings (accessory) during the GOT installation to the panel (4 holes at top and bottom)
4)	Rating plate (nameplate)	--
5)	CF card access LED	Lit: CF card accessed Not lit: CF card not accessed
6)	CF card access switch	Switch for prohibiting access to CF card before removing the CF card from the GOT ON: CF card being accessed (CF card removal prohibited) OFF: No access to CF card (CF card removal possible)
7)	CF card cover	Open or close when inserting or removing the CF card.
8)	Reset switch	Hardware reset switch (Use an isolated rod to operate.)
9)	Battery cover	Open or close when replacing the battery.
10)	Power terminal	Power terminal and FG terminal (for power supply (24VDC) to GOT and grounding)
11)	Power terminal cover	Open or close when connecting a power terminal. (Color: transparent)
12)	CF card interface	Interface for installing the CF card to GOT
13)	CF card eject button	Button for removing the CF card
14)	Battery	GT11-50BAT battery for storing clock data, alarm history and recipe data (The project data is stored in the built-in flash memory.)

For the connection to the controller (PLC, microcomputer board, bar code reader, RFID, etc) or PC, refer to the following.

→ **GOT 1000 Series Connection Manual**

3. Specifications

3.1 General Specifications

Item		Specifications				
Operating ambient temperature	Display section	0 to 50°C				
	Other than display section	0 to 55°C (When mounted horizontally), 0 to 50°C (When mounted vertically)				
Storage ambient temperature		-20 to 60°C				
Operating ambient humidity		10 to 90% RH, non-condensing (STN liquid crystal type to be stored at or below 39°C WBT.)				
Storage ambient humidity		10 to 90% RH, non-condensing (STN liquid crystal type to be stored at or below 39°C WBT.)				
Vibration resistance	Conforms to JIS B3502 and IEC61131-2	Under intermittent vibration	Frequency	Acceleration	Half-amplitude	Sweep Count
		Under continuous vibration	5 to 9Hz	--	3.5mm	
			9 to 150Hz	9.8m/s ²	--	
Shock resistance		Conforms to JIS B3502, IEC 61131-2 (147 m/s ² , 3 times each in X, Y and Z directions)				
Operating atmosphere		Must be free of lamp black, corrosive gas, flammable gas, or excessive amount of electroconductive dust particles and must be no direct sunlight. (Same as for saving)				
Operating altitude ¹⁾		2000 m (6562 ft) max.				
Installation location		Inside control panel				
Overvoltage category ²⁾		II or less				
Pollution degree ³⁾		2 or less				
Cooling method		Self-cooling				

¹⁾ Do not use or store the GOT under pressure higher than the atmospheric pressure of altitude 0m (0ft.). Failure to observe this instruction may cause a malfunction.

²⁾ This indicates the section of the power supply to which the equipment is assumed to be connected between the public electrical power distribution network and the machinery within the premises.
Category II applies to equipment for which electrical power is supplied from fixed facilities.
The surge voltage withstand level for up to the rated voltage of 300 V is 2500 V.

³⁾ This index indicates the degree to which conductive material is generated in the environment where the equipment is used.
In pollution degree 2, only non-conductive pollution occurs but temporary conductivity may be produced due to condensation.

3.2 Performance Specifications

Item		Specifications		
		GT1155-QTBD	GT1155-QSBD	GT1150-QLBD
Display section ¹⁾	Type	TFT color liquid crystal	STN color liquid crystal	STN monochrome (white/black) liquid crystal
	Screen size	5.7"		
	Resolution	320 × 240 dots		
	Display size	W115(4.53) × H86(3.39)[mm](inch) (Horizontal format)		
	Display character	16-dot standard font: 20 characters × 15 lines, 12-dot standard font: 26 characters × 20 lines		
	Display color	256 colors	Monochrome (white/black), 16 scales	
	Display angle	Left/Right: 70 degrees, Top: 70 degrees, Bottom: 50 degrees (Horizontal format)	Left/Right: 55 degrees, Top: 65 degrees, Bottom: 70 degrees (Horizontal format)	Left/Right: 45 degrees, Top: 20 degrees, Bottom: 40 degrees (Horizontal format)
	Contrast adjustment	--	16-level adjustment	
	Intensity of LCD only	400[cd/m ²](Adjustable in 8 levels)	380[cd/m ²](Adjustable in 8 levels)	220[cd/m ²](Adjustable in 8 levels)
	Intensity adjustment	8-level adjustment		
Life	Approx. 50,000h. (Time for display intensity to become 1/5 at operating ambient temperature of 25°C)			
Backlight	Cold cathode fluorescent tube (irreplaceable by a user) backlight shutoff detection function is included. Backlight off/screen saving time can be set.			
Life ²⁾	Approx. 75,000h or longer (Time for display intensity reaches 50% at the operating ambient temperature of 25°C) Approx. 54,000h or longer (Time for display intensity reaches 50% at the operating ambient temperature of 25°C)			
Touch panel	Number of touch keys	300 keys/screen (Matrix structure of 15 lines × 20 columns)		
	Key size	Minimum 16 × 16 dots (per key)		
	Number of points touched simultaneously	Maximum of 2 points		
	Life	1 million times or more (operating force 0.98N max.)		
Memory	C drive ³⁾	Flash memory (Internal), for storing project data (3Mbytes) and OS		
	Life (Number of write times)	100,000 times		
	D drive	SRAM (Internal), 512kbytes (battery backup)		

Item	Specifications		
	GT1155-QTBD	GT1155-QSBD	GT1150-QLBD
Battery	GT11-50BAT lithium battery		
Backup target	Clock data, alarm history and recipe data		
Life	Approx. 5 years (Operating ambient temperature of 25°C)		
Built-in interface	RS-422	RS422 1ch Transmission speed: 115,200/57,600/38,400/19,200/9,600/4,800bps Connector shape: D-sub 9-pin (Female) Application: PLC communication	
	RS-232	RS232 1ch Transmission speed: 115,200/57,600/38,400/19,200/9,600/4,800bps Connector shape: D-sub 9-pin (Male) Application: PLC communication, bar code reader, RFID connection, PC communication (Project data upload/download, OS installation, transparent function)	
	USB	USB (Full Speed 12Mbps), device, 1ch Application: PC communication (Project data upload/download, OS installation, transparent function)	
	CF card	Conforming to PCMCIA, compact flash slot, 1ch Connector shape: Dedicated for TYPE I Application: Data transfer, data storage	
Buzzer output	Single tone (tone length adjustable)		
Environmental protective structure ⁴	Equivalent to IP67 (JEM1030) when the USB environmental protective cover is attached		
External dimensions	W164(6.46) × H135(5.32) × D56(2.21)[mm](inch)(Excluding USB environmental protective cover) (Horizontal format)		
Panel cutting dimensions	W153 (6.03) × H121(4.77)[mm] (inch) (Horizontal format)		
Weight	0.7kg (Excluding mounting fixtures)		
Compatible software package	GT Designer2 Version2 or later		

- *1 Bright dots (always lit) and dark dots (unlit) may appear on a liquid crystal display panel. It is impossible to completely avoid this symptom, as the liquid crystal display comprises of a great number of display elements. Flickers may be observed depending on the display color.
Please note that these dots appear due to its characteristic and are not caused by product defect.
When the same screen is displayed for a long time, an incidental color or partial discoloration is generated on the screen due to heat damage, and it may not disappear. To prevent heat damage, the screen saver function is effective.
For details on the screen saver function, refer to the following.
→ GT11 User's Manual
- *2 Using the GOT Backlight OFF function can prolong the life of the backlight.
For details on the Backlight OFF function, refer to the following.
→ GT11 User's Manual
- *3 ROM in which new data can be written without deleting the written data.
- *4 Compliant with IP67 when the USB environmental protection cover is attached. Not compliant when a USB cable is connected. Note that this does not guarantee all users' operation environment.

3.3 Power Supply Specifications

Item	Specifications		
	GT1155-QTBD	GT1155-QSBD	GT1150-QLBD
Input power supply voltage	24VDC (+10% -15%), ripple voltage 200mV or less		
Fuse (built-in, not exchangeable)	1.0A		
Power consumption	9.84W (410mA/24VDC) or less	9.36W (390mA/24VDC) or less	
At backlight off	4.32W (180mA/24VDC) or less		
Inrush current	15A or less (26.4V) 2ms		
Permissible instantaneous power failure time ^{*1}	Within 5ms		
Noise immunity	Noise voltage: 1000Vp-p, Noise width: 1μs (by noise simulator of 30 to 100Hz noise frequency)		
Dielectric withstand voltage	500VAC for 1 minute (across power supply terminals and earth)		
Insulation resistance	10MΩ or larger by insulation resistance tester (across power supply terminals and earth)		
Applicable wire size	0.75 to 2[mm ²]		
Applicable solderless terminal	Solderless terminal for M3 screw RAV1.25-3, V2-N3A, FV2-N3A		
Applicable tightening torque (Terminal block terminal screw)	0.5 to 0.8[N·m]		

- *1 The GOT continues to operate even upon 5ms or shorter instantaneous power failure.
The GOT stops operating if there is extended power failure or voltage drop, while it automatically resumes operation as soon as the power is restored.

3.4 External Dimensions

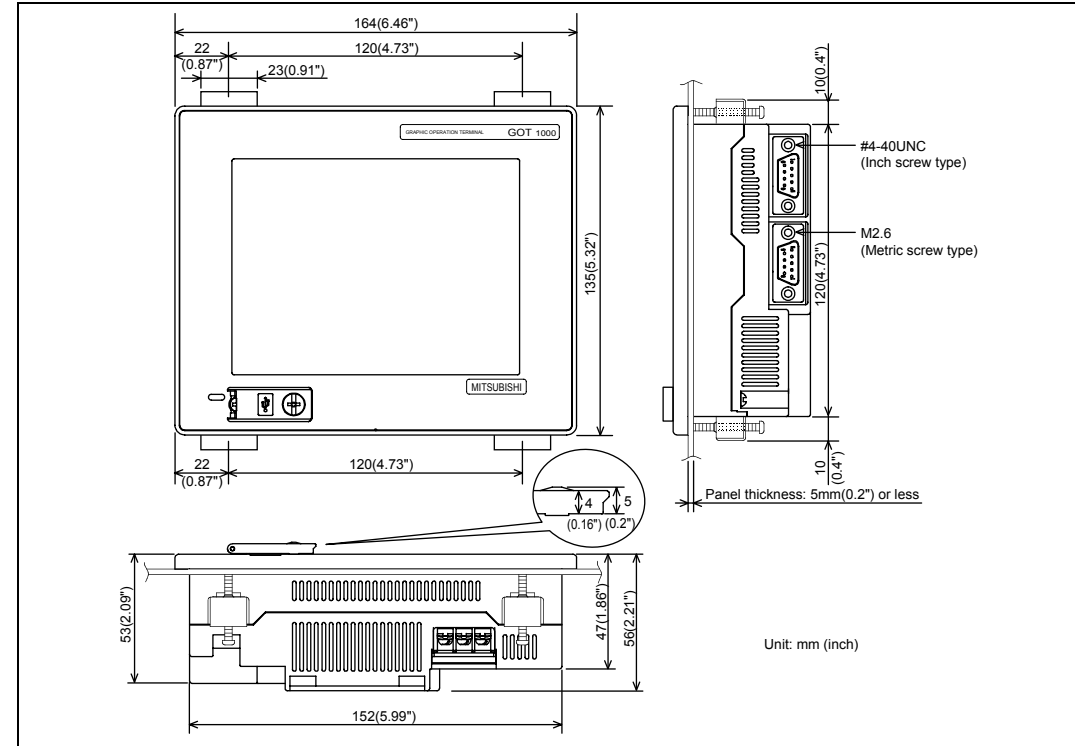

4. Installation

4.1 Control Panel Inside Dimensions for Mounting GOT

Mount the GOT onto the control panel while considering the following control panel inside dimensions.

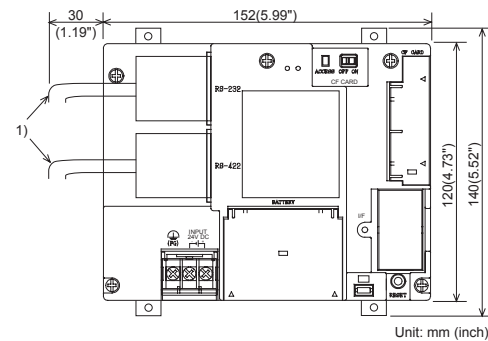

4.2 Panel Cutting Dimensions

Make holes in the panel according to the dimensions list below. Also, ensure 10mm spaces in upper and lower parts of the panel for mounting fixtures.

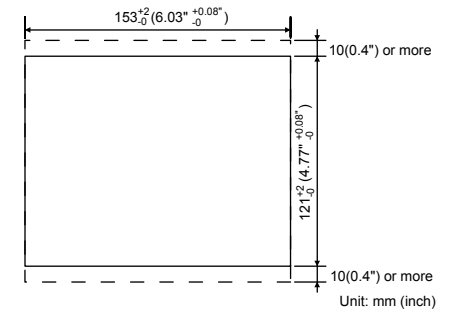

No	Name
1)	PLC connection cable/PC connection cable

Applicable cable

Some cables may need to be longer than the specified dimensions when connecting to the GOT. Therefore, consider the connector dimensions and bending radius of the cable as well for installation.

4.3 Mounting Position

When mounting the GOT, the clearances shown on the right must be left from a structure or the other device.

Installation Environment	A,D	B	C		E
			When the CF card is not used	When the CF card is used	
In the presence of radiated-noise or heat-generating equipment nearby	50 mm (1.97") or more	80 mm (3.14") or more*1	50 mm (1.97") or more*2	100 mm (3.93") or more	100 mm (3.93") or more
In the absence of radiated-noise or heat-generating equipment nearby	20 mm (0.79") or more	20 mm (0.79") or more	20 mm (0.79") or more	100 mm (3.93") or more	20 mm (0.79") or more

- *1 Vertical format....50 mm (1.97") or more (20 mm (0.79") or more)
- *2 Horizontal format....80 mm (3.14") or more (20 mm (0.79") or more)

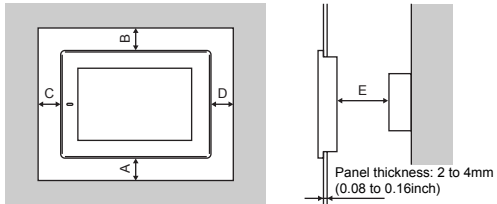

4.4 Control Panel Inside Temperature and Mounting Angle

When mounting the main unit to a control panel or similar, set the display section as shown below.

When the temperature inside the control panel is 40 to 55°C (Horizontal mount), 40 to 50°C (Vertical mount), the mounting angle should be in the range 60° to 105° degrees.

- The GOT will be deteriorated earlier if it is used at the mounting angle other than the above. Therefore, the temperature inside the control panel should be within 40°C.

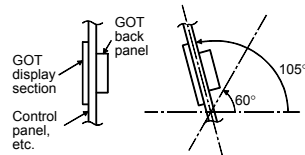

4.5 Installation Procedure

The GOT is designed to be embedded into a panel. Mount the GOT by following the procedure below. For panel cutting dimensions, refer to Section 4.2. Note that the panel thickness should be within 5mm.

- Installing the packing
 - Install packing to the packing installation groove on the back panel of the GOT.
 - While referring to the cross sectional view of the packing shown right, push the thinner side into the packing groove.
 - (Right drawing is the example of lateral format.)

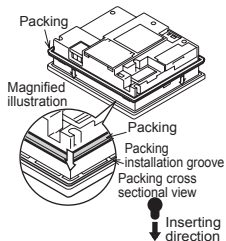

- Inserting into the panel face
 - Insert the GOT from the front side of the panel.

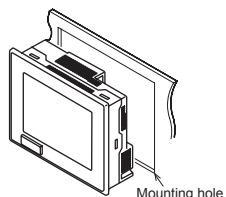

- Fixing the GOT
 - Engage the hook of the mounting fitting (accessory) to the unit fixing hole of the GOT and tighten the screw until the GOT is fixed with the mounting bolt (accessory).
 - The GOT will be fixed in 4 upper/lower parts.
 - Tighten the mounting screw with the specified torque.
 - (Failure to do so may distort the panel and make a surface waviness on the protective sheet.)

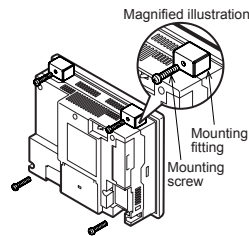

- A protection film is attached on the display section of GOT prior to shipment. Remove the film when the installation is completed.

5. Wiring

5.1 Power Supply Wiring

Connect the power supply to the power terminals on the back panel of the GOT. Use 0.75mm² or thicker cables to avoid voltage drop and tighten the terminal screw with the specified torque securely.

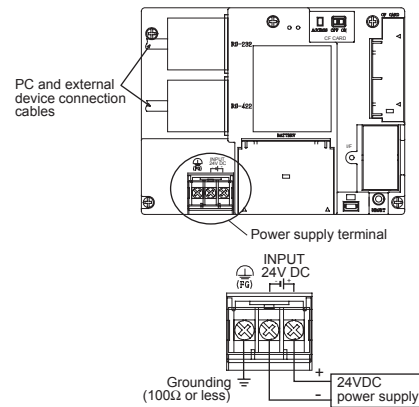

- Carry out the independent grounding if possible.
- If the independent grounding is impossible, carry out the shared grounding as shown in fig.2) below.
- Use the cable of 2mm² or more for grounding. Set the grounding point closer to the GOT to make the grounding cable short as possible.

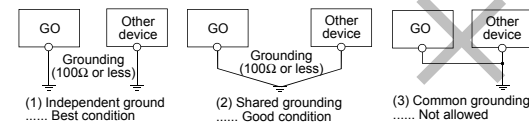

1) Recommended terminal shape

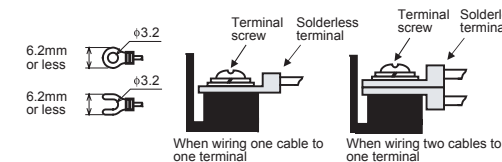

Applicable solderless terminal	RAV 1.25-3, V2-N3A and FV2-N3A
--------------------------------	--------------------------------

6. Maintenance and Inspection

The GOT does not include consumable components that will cause the shorten life. However, note that battery life is 5 years and LCD life is 50,000 hours. The life of backlight in GT1155-QTBD, GT1155-QSBD is 75,000 hours and that in GT1150-QLBD is 54,000 hours.

It is recommended to replace the battery periodically. (For the replacement of the liquid crystal screen and backlight, please consult your nearest sales office or FA Center.)

6.1 Daily Inspection

No.	Inspection Item	Inspection Method	Criterion	Action
1	GOT mounting status	Check for loose mounting screws.	Securely mounted	Retighten screws within the specified torque range
2	Loose terminal screws	Retighten screws with screwdriver	Not loose	Retighten terminal screws
	Proximate solderless terminals	Visual check	Proper intervals	Correct
3	Loose connectors	Visual check	Not loose	Retighten connector fixing screws
	Dirt on protection sheet	Visual check	Not outstanding	Replace with new one
Usage status	Foreign material attachment	Visual check	No foreign matter sticking	Remove clean

Refer to the following for the model names of the protection sheet or the replacement procedure. → GT11 User's Manual

6.2 Periodic Inspection

Yearly or half-yearly inspection items
The following inspection should also be performed when equipment has been moved or modified or the wiring changed.

No.	Inspection Item	Inspection Method	Criterion	Action	
1	Surrounding environment	Ambient temperature	Make measurement with thermometer or hygrometer Measure corrosive gas	Display section 0 to 50°C Other portions 0 to 55°C	For use in control panel, temperature inside control panel is ambient temperature
		Ambient humidity	10 to 90%RH	No corrosive gas	
		Atmosphere	No corrosive gas		
2	Power supply voltage check	24VDC Measure voltage across terminals.	20.4 to 26.4VDC	Change supply power	
3	Mounting status	Looseness	Move module	Should be mounted firmly	Retighten screws
		Dirt, foreignmatter	Visual check	No dirt, foreign matter sticking	Remove, clean
4	Connection status	Loose terminal screws	Retighten screws with screwdriver	Not loose	Retighten terminal screws
		Proximate solderless terminals	Visual check	Proper intervals	Correct
		Loose connectors	Visual check	Not loose	Retighten connector fixing screws
5	Battery	Check the system alarm (error code: 500) report on the Alarm Information screen	(Preventive maintenance)	Replace with new battery when the current battery has reached the specified life span, even if battery voltage is not displayed.	

6.3 Battery Replacement

The battery is used for backing up the clock data, alarm history or recipe data. Screen data is stored in the flash memory and data is retained even if the battery is dead.

- Battery model name
GT11□□ is shipped with the following battery.

Product name	Model name
Battery	GT11-50BAT

- Battery replacement procedure
 - Turn the GOT power off.
 - Open the back cover of the GOT.
 - Remove the old battery from the holder.
 - Disconnect the old battery connector and insert the new battery connector within 30s.
 - Insert the new battery into the holder and close the back cover.
 - Turn the GOT power on.
 - Check if the battery condition is normal with the utility.
Refer to the following for the details of battery status display.
→ GT11 User's Manual

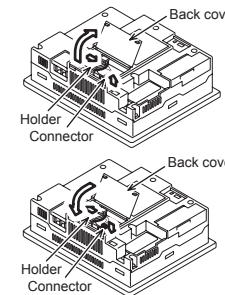

- How to confirm production year and month
The production year and month of the battery built in the purchased GOT can be confirmed by the production No. (serial No.) marked on the GOT main unit.

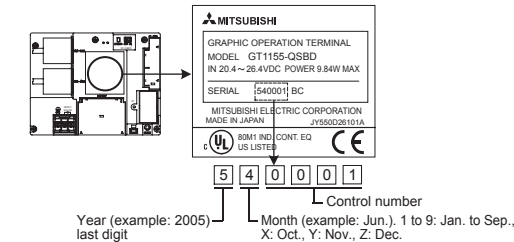

The production date of the battery built in the purchased GOT can be confirmed by the production No. (serial No.) marked on the GOT main unit.

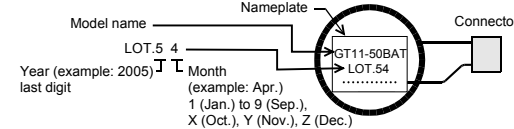

- Battery life
Approximate battery life:
5 years (ambient temperature: 25°C)
Battery replacement: In 4 to 5 years

Approximate life is 5 years, but life may be shorter depending on the ambient temperature, therefore, note that the battery must be replaced in 4 to 5 years. Make sure to purchase a new battery as needed as it self-discharges.

Battery status can be confirmed on a GOT utility screen.
For details of battery status or how to output alarm, refer to the following:
→ GT11 User's Manual

This manual confers no industrial property rights or any rights of any other kind, nor does it confer any patent licenses. Mitsubishi Electric Corporation cannot be held responsible for any problems involving industrial property rights which may occur as a result of using the contents noted in this manual.

Warranty
Mitsubishi will not be held liable for damage caused by factors found not to be the cause of Mitsubishi; opportunity loss or lost profits caused by faults in the Mitsubishi products; damage, secondary damage, accident compensation caused by special factors unpredictable by Mitsubishi; damages to products other than Mitsubishi products; and to other duties.

⚠ For safe use

- This product has been manufactured as a general-purpose part for general industries, and has not been designed or manufactured to be incorporated in a device or system used in purposes related to human life.
- Before using the product for special purposes such as nuclear power, electric power, aerospace, medicine or passenger movement vehicles, consult with Mitsubishi Electric.
- This product has been manufactured under strict quality control. However when installing the product where major accidents or losses could occur if the product fails, install appropriate backup or failsafe functions in the system.

MITSUBISHI *Changes for the Better*

GT1155-QTBD, GT1155-QSBD, GT1150-QLBD

GT11 General Description

Manual Number	JY997D17401H
Date	Jul. 2008

GOT1000

This manual describes the part names, dimensions, mounting, and specifications of the product. Before use, read this manual and manuals of relevant products fully to acquire proficiency in handling and operating the product. Make sure to learn all the product information, safety information, and precautions.

And, store this manual in a safe place so that you can take it out and read it whenever necessary. Always forward it to the end user.

Registration

The company name and the product name to be described in this manual are the registered trademarks or trademarks of each company.

Effective May 2008
Specifications are subject to change without notice.

© 2008 Mitsubishi Electric Corporation

Safety Precaution (Read these precautions before using.)

Before using this product, please read this manual and the relevant manuals introduced in this manual carefully and pay full attention to safety to handle the product correctly.

The precautions given in this manual are concerned with this product. In this manual, the safety precautions are ranked as "DANGER" and "CAUTION".

DANGER	Indicates that incorrect handling may cause hazardous conditions, resulting in death or severe injury.
CAUTION	Indicates that incorrect handling may cause hazardous conditions, resulting in medium or slight personal injury or physical damage.

Depending on circumstances, procedures indicated by "CAUTION" may also be linked to serious results. In any case, it is important to follow the directions for usage.

DESIGN PRECAUTIONS **DANGER**

- Some failures of the GOT or cable may keep the outputs on or off. An external monitoring circuit should be provided to check for output signals which may lead to a serious accident. Not doing so can cause an accident due to false output or malfunction.
- If a communication fault (including cable disconnection) occurs during monitoring on the GOT, communication between the GOT and PLC CPU is suspended and the GOT becomes inoperative. A system where the GOT is used should be configured to perform any significant operation to the system by using the switches of a device other than the GOT on the assumption that a GOT communication fault will occur. Not doing so can cause an accident due to false output or malfunction.
- Do not use the GOT as the warning device that may cause a serious accident. An independent and redundant hardware or mechanical interlock is required to configure the device that displays and outputs serious warning. Failure to observe this instruction may result in an accident due to incorrect output or malfunction.
- Incorrect operation of the touch switch(es) may lead to a serious accident if the GOT backlight is gone out. When the GOT backlight goes out, the POWER LED flickers (green/orange) and the display section turns black and causes the monitor screen to appear blank, while the input of the touch switch(es) remains active. This may confuse an operator in thinking that the GOT is in "screensaver" mode, who then tries to release the GOT from this mode by touching the display section, which may cause a touch switch to operate. Note that the following occurs on the GOT when the backlight goes out.
 - The POWER LED flickers (green/orange) and the monitor screen appears blank

DESIGN PRECAUTIONS **CAUTION**

- Do not bundle the control and communication cables with main-circuit, power or other wiring. Run the above cables separately from such wiring and keep them a minimum of 100mm (3.94in.) apart. Not doing so noise can cause a malfunction.

MOUNTING PRECAUTIONS **DANGER**

- Be sure to shut off all phases of the external power supply used by the system before mounting or removing the GOT to/from the panel. Not doing so can cause the unit to fail or malfunction.
- When installing the battery, or operating the reset switch, wear an earth band etc. to avoid the static electricity. The static electricity can cause the unit to fail or malfunction.

MOUNTING PRECAUTIONS **CAUTION**

- Use the GOT in the environment that satisfies the general specifications described in this manual. Not doing so can cause an electric shock, fire, malfunction or product damage or deterioration.
- When mounting the GOT to the control panel, tighten the mounting screws in the specified torque range. Undertightening can cause the GOT to drop, short circuit or malfunction. Overtightening can cause a drop, short circuit or malfunction due to the damage of the screws or the GOT.
- When inserting/removing a CF card into/from the GOT, turn the CF card access switch off in advance. Failure to do so may corrupt data within the CF card.
- When inserting a CF card into the GOT, push it into the insertion slot until the CF card eject button will pop out. Failure to do so may cause a malfunction due to poor contact.
- When removing a CF card from the GOT, make sure to support the CF card by hand, as it may pop out. Failure to do so may cause the CF card to drop from the GOT and break.

WIRING PRECAUTIONS **DANGER**

- Be sure to shut off all phases of the external power supply used by the system before wiring. Failure to do so may result in an electric shock, product damage or malfunctions.
- Please make sure to ground FG terminal of the GOT power supply section by applying 100 or less which is used exclusively for the GOT. Not doing so may cause an electric shock or malfunction.
- Correctly wire the GOT power supply section after confirming the rated voltage and terminal arrangement of the product. Not doing so can cause a fire or failure.
- Tighten the terminal screws of the GOT power supply section in the specified torque range. Undertightening can cause a short circuit or malfunction. Overtightening can cause a short circuit or malfunction due to the damage of the screws or the GOT.
- Exercise care to avoid foreign matter such as chips and wire offcuts entering the GOT. Not doing so can cause a fire, failure or malfunction.

WIRING PRECAUTIONS **CAUTION**

- Plug the communication cable into the connector of the connected unit and tighten the mounting and terminal screws in the specified torque range. Undertightening can cause a short circuit or malfunction. Overtightening can cause a short circuit or malfunction due to the damage of the screws or unit.

TEST OPERATION PRECAUTIONS **DANGER**

- Before performing the test operations of the user creation monitor screen (such as turning ON or OFF bit device, changing the word device current value, changing the settings or current values of the timer or counter, and changing the buffer memory current value), read through the manual carefully and make yourself familiar with the operation method. During test operation, never change the data of the devices which are used to perform significant operation for the system. False output or malfunction can cause an accident.

STARTUP/MAINTENANCE PRECAUTIONS **DANGER**

- When power is on, do not touch the terminals. Doing so can cause an electric shock or malfunction.
- Connect the battery correctly. Do not discharge, disassemble, heat, short, solder or throw the battery into the fire. Incorrect handling may cause the battery to generate heat, burst or take fire, resulting in injuries or fires.
- Before starting cleaning or terminal screw retightening, always switch off the power externally in all phases. Not switching the power off in all phases can cause a unit failure or malfunction. Undertightening can cause a short circuit or malfunction. Overtightening can cause a short circuit or malfunction due to the damage of the screws or unit.

STARTUP/MAINTENANCE PRECAUTIONS **CAUTION**

- Do not disassemble or modify the unit. Doing so can cause a failure, malfunction, injury or fire.
- Do not touch the conductive and electronic parts of the unit directly. Doing so can cause a unit malfunction or failure.
- The cables connected to the unit must be run in ducts or clamped. Not doing so can cause the unit or cable to be damaged due to the dangling, motion or accidental pulling of the cables or can cause a malfunction due to a cable connection fault.
- When unplugging the cable connected to the unit, do not hold and pull the cable portion. Doing so can cause the unit or cable to be damaged or can cause a malfunction due to a cable connection fault.
- Do not drop or apply any impact to the battery. If any impact has been applied, discard the battery and never use it. The battery may be damaged by the drop or impact.
- Before touching the unit, always touch grounded metal, etc. to discharge static electricity from human body, etc. Not doing so can cause the unit to fail or malfunction.

DISPOSAL PRECAUTIONS **CAUTION**

- When disposing of the product, handle it as industrial waste.

TRANSPORTATION PRECAUTIONS **CAUTION**

- When transporting lithium batteries, make sure to treat them based on the transport regulations.
- Before transporting the GOT, turn the GOT power on and check that the battery voltage status is normal on the Time setting & display screen (utilities screen). In addition, confirm that the adequate battery life remains on the rating plate. Transporting the GOT with the low battery voltage or the battery the reached battery life may destabilize the backup data unstable during transportation.
- Make sure to transport the GOT main unit and/or relevant unit(s) in the manner they will not be exposed to the impact exceeding the impact resistance described in the general specifications of this manual, as they are precision devices. Failure to do so may cause the unit to fail. Check if the unit operates correctly after transportation.

Associated Manuals

The following manuals are relevant to this product. When these loose manuals are required, please consult with our local distributor.

Manual name	Contents	Manual Number (Model Code)
GOT1000 Series Extended/Option Function Manual (sold separately) *1	Describes extended functions and option functions applicable to GOT1000 series.	SH-080544ENG (1D7M32)
GOT1000 Series Connection Manual 1/3, 2/3, 3/3 (sold separately) *1	Describes system configurations of the connection method applicable to GOT1000 series and cable creation method	SH-080532ENG (1D7M26)
GT Designer2 Version2 Basic Operation/Data Transfer Manual (For GOT1000 Series) (sold separately) *1	Describes methods of the GT Designer2 installation operation, basic operation for drawing and transmitting data to GOT1000 series	SH-080529ENG (1D7M24)
GT Designer2 Version2 Screen Design Manual (For GOT1000 Series) 1/3, 2/3, 3/3 (sold separately) *1	Describes specifications and settings of the object functions used in GT Designer2	SH-080530ENG (1D7M25)

*1 Stored in the GT Works 2/GT Designer2 in PDF format.

For details of a PLC to be connected, refer to the PLC user's manual respectively.

Bundled Items

Product Name	Model Name	Specifications
GOT	GT1155-QTBD	5.7" diagonal [320 x 240 dots], TFT color LCD (256 colors), built-in battery and backlight
	GT1155-QSBD	5.7" diagonal [320 x 240 dots], STN color LCD (256 colors), built-in battery and backlight
	GT1150-QLBD	5.7" diagonal [320 x 240 dots], STN monochrome LCD (black/white, 16 scales), built-in battery and backlight

Bundled item	Quantity	Bundled item	Quantity
Mounting brackets	4	Dust-/Water-proof packing	1
Mounting screws: M4 x 35mm (1.38")	4	GT11 General Description (This manual)	1

1. Features

- Improved monitoring performance and connectivity to FA devices
 - Multiple languages are displayed using the Unicode2.1-compatible fonts and beautiful characters are drawn using the TrueType and high quality fonts.
 - Two types of display modes are provided: 256-color display and monochrome display. In the monochrome display, 16 scales are used to improve the display.
 - High-speed monitoring through high-speed serial communication at maximum rate of 115.2 kbps or through bus connection with the PLC.
 - High speed display and high speed touch switch response.
- More efficient GOT operations including screen design, startup, adjustment, management and maintenance works
 - The 3MB user memory is included as standard.
 - CF card interface is included as standard.
 - The USB connector is positioned on the GOT front. This enables the system startup to be performed more efficiently using FA device setup tool, and eliminates the indirect works (opening and closing the control panel, cable replacement, cable rewiring) in order to improve the working efficiency.
- Enhanced support of FA setup tools
 - PLC program transfer and monitoring are possible via the personal computer that is connected to the GOT if connected directly to the A, QnA, Q, or FX series of the PLC CPU (FA transparent function).

2. Part Name

2.1 Front Panel

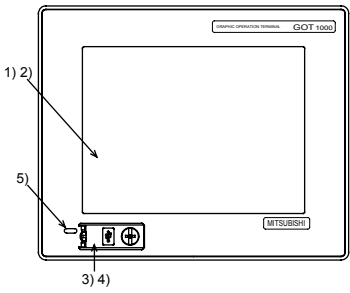

2.2 Back Panel

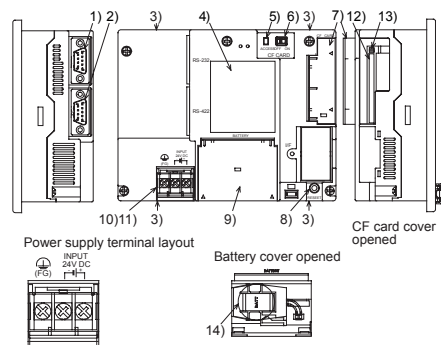

No.	Name	Specifications
1)	Display screen	Displays the utility screen and the user creation screen. GT1155-QTBD:320x240 dots, TFT color liquid crystal GT1155-QSBD:320x240 dots, STN color liquid crystal GT1150-QLBD:320x240 dots, STN monochrome (white/black) liquid crystal, 16 scales
2)	Touch key	For operating the touch switches in the utility screen and the user creation screen
3)	USB interface	USB interface for connecting a personal computer (OS installation, project data download, transparent)
4)	USB environmental protection cover	Opens/Closes when the USB interface is used.
5)	POWER LED	Lit in green : Power is correctly supplied Lit in orange : Screen saving Blinking in orange/green : Blown backlight bulb Not lit : Power is not supplied

For the PC connection, refer to the following.
→ GT Designer2 Version □ Basic Operation/Data Transfer Manual

No.	Name	Specifications
1)	RS-232 interface	For communicating with controller (PLC, microcomputer board, bar code reader, RFID, etc) or personal computer (OS installation, project data download, transparent) (D-sub 9-pin male)
2)	RS-422 interface	For communicating with controller (PLC, microcomputer board, etc) (D-sub 9-pin female)
3)	Hole for unit installation fitting	Hole for the inserting installation fittings (accessory) during the GOT installation to the panel (4 holes at top and bottom)
4)	Rating plate (nameplate)	--
5)	CF card access LED	Lit: CF card accessed Not lit: CF card not accessed
6)	CF card access switch	Switch for prohibiting access to CF card before removing the CF card from the GOT. ON: CF card being accessed (CF card removal prohibited) OFF: No access to CF card (CF card removal possible)
7)	CF card cover	Open or close when inserting or removing the CF card.
8)	Reset switch	Hardware reset switch (Use an isolated rod to operate.)
9)	Battery cover	Open or close when replacing the battery.
10)	Power terminal	Power terminal and FG terminal (for power supply (24VDC) to GOT and grounding)
11)	Power terminal cover	Open or close when connecting a power terminal. (Color: transparent)
12)	CF card interface	Interface for installing the CF card to GOT
13)	CF card eject button	Button for removing the CF card
14)	Battery	GT11-50BAT battery for storing clock data, alarm history and recipe data. (The project data is stored in the built-in flash memory.)

For the connection to the controller (PLC, microcomputer board, bar code reader, RFID, etc) or PC, refer to the following.
→ GOT 1000 Series Connection Manual

3. Specifications

3.1 General Specifications

Item	Specifications
Operating ambient temperature	Display section: 0 to 50°C
	Other than display section: 0 to 55°C (When mounted horizontally), 0 to 50°C (When mounted vertically)
Storage ambient temperature	-20 to 60°C
Operating ambient humidity	10 to 90% RH, non-condensing (STN liquid crystal type to be stored at or below 39°C WBT.)
Storage ambient humidity	10 to 90% RH, non-condensing (STN liquid crystal type to be stored at or below 39°C WBT.)
Vibration resistance	Conforms to JIS B3502 and IEC61131-2
	Under intermittent vibration: 5 to 9Hz, 9 to 150Hz, 9.8m/s ² Under continuous vibration: 5 to 9Hz, 9 to 150Hz, 4.9m/s ²
Shock resistance	Conforms to JIS B3502, IEC 61131-2 (147 m/s ² , 3 times each in X, Y and Z directions)
Operating atmosphere	Must be free of lamp black, corrosive gas, flammable gas, or excessive amount of electroconductive dust particles and must be no direct sunlight. (Same as for saving)
Operating altitude ^{*1}	2000 m (6562 ft) max.
Installation location	Inside control panel
Overvoltage category ^{*2}	II or less
Pollution degree ^{*3}	2 or less
Cooling method	Self-cooling

*1 Do not use or store the GOT under pressure higher than the atmospheric pressure of altitude 0m (0ft.). Failure to observe this instruction may cause a malfunction.
*2 This indicates the section of the power supply to which the equipment is assumed to be connected between the public electrical power distribution network and the machinery within the premises. Category II applies to equipment for which electrical power is supplied from fixed facilities. The surge voltage withstand level for up to the rated voltage of 300 V is 2500 V.
*3 This index indicates the degree to which conductive material is generated in the environment where the equipment is used. In pollution degree 2, only non-conductive pollution occurs but temporary conductivity may be produced due to condensation.

3.2 Performance Specifications

Item	Specifications		
	GT1155-QTBD	GT1155-QSBD	GT1150-QLBD
Type	TFT color liquid crystal	STN color liquid crystal	STN monochrome (white/black) liquid crystal
Screen size	5.7"		
Resolution	320 x 240 dots		
Display size	W115(4.53) x H86(3.39)[mm](inch) (Horizontal format)		
Display character	16-dot standard font: 20 characters x 15 lines, 12-dot standard font: 26 characters x 20 lines		
Display color	256 colors		Monochrome (white/black), 16 scales
Display angle	Left/Right: 70 degrees, Top: 70 degrees, Bottom: 50 degrees (Horizontal format)	Left/Right: 55 degrees, Top: 65 degrees, Bottom: 70 degrees (Horizontal format)	Left/Right: 45 degrees, Top: 20 degrees, Bottom: 40 degrees (Horizontal format)
Contrast adjustment	--	16-level adjustment	
Intensity of LCD only	400[cd/m ²](Adjustable in 8 levels)	380[cd/m ²](Adjustable in 8 levels)	220[cd/m ²](Adjustable in 8 levels)
Intensity adjustment	8-level adjustment		
Life	Approx. 50,000h. (Time for display intensity to become 1/5 at operating ambient temperature of 25°C)		
Backlight	Cold cathode fluorescent tube (irreplaceable by a user) backlight shutoff detection function is included. Backlight off/screen saving time can be set.		
Life ^{*2}	Approx. 75,000h or longer (Time for display intensity reaches 50% at the operating ambient temperature of 25°C)	Approx. 54,000h or longer (Time for display intensity reaches 50% at the operating ambient temperature of 25°C)	
Touch panel	Number of touch keys	300 keys/screen (Matrix structure of 15 lines x 20 columns)	
	Key size	Minimum 16 x 16 dots (per key)	
	Number of points touched simultaneously	Maximum of 2 points	
Memory	Life (Number of write times)	1 million times or more (operating force 0.98N max.)	
	C drive ^{*3}	Flash memory (Internal), for storing project data (3Mbytes) and OS	
Memory	Life (Number of write times)	100,000 times	
	D drive	SRAM (Internal), 512kbytes (battery backup)	

Item	Specifications		
	GT1155-QTBD	GT1155-QSBD	GT1150-QLBD
Battery	GT11-50BAT lithium battery		
Backup target	Clock data, alarm history and recipe data		
Life	Approx. 5 years (Operating ambient temperature of 25°C)		
Built-in interface	RS-422	RS422 1ch Transmission speed: 115,200/57,600/38,400/19,200/9,600/4,800bps Connector shape: D-sub 9-pin (Female) Application: PLC communication	
	RS-232	RS232 1ch Transmission speed: 115,200/57,600/38,400/19,200/9,600/4,800bps Connector shape: D-sub 9-pin (Male) Application: PLC communication, bar code reader, RFID connection, PC communication (Project data upload/download, OS installation, transparent function)	
	USB	USB (Full Speed 12Mbps), device, 1ch Application: PC communication (Project data upload/download, OS installation, transparent function)	
	CF card	Conforming to PCMCIA, compact flash slot, 1ch Connector shape: Dedicated for TYPE I Application: Data transfer, data storage	
Buzzer output	Single tone (tone length adjustable)		
Environmental protective structure ⁴	Equivalent to IP67 (JEM1030) (front section) when the USB environmental protective cover is attached		
External dimensions	W164(6.46) × H135(5.32) × D56(2.21)[mm](inch)(Excluding USB environmental protective cover) (Horizontal format)		
Panel cutting dimensions	W153(6.03) × H121(4.77)[mm] (inch) (Horizontal format)		
Weight	0.7kg (Excluding mounting fixtures)		
Compatible software package	GT Designer2 Version2 or later		

- *1 Bright dots (always lit) and dark dots (unlit) may appear on a liquid crystal display panel. It is impossible to completely avoid this symptom, as the liquid crystal display comprises of a great number of display elements. Flickers may be observed depending on the display color. Please note that these dots appear due to its characteristic and are not caused by product defect. When the same screen is displayed for a long time, an incidental color or partial discoloration is generated on the screen due to heat damage, and it may not disappear. To prevent heat damage, the screen saver function is effective. For details on the screen saver function, refer to the following.
→ GT11 User's Manual
- *2 Using the GOT Backlight OFF function can prolong the life of the backlight. For details on the Backlight OFF function, refer to the following.
→ GT11 User's Manual
- *3 ROM in which new data can be written without deleting the written data.
- *4 Compliant with IP67 when the USB environmental protection cover is attached. Not compliant when a USB cable is connected. Note that this does not guarantee all users' operation environment.

3.3 Power Supply Specifications

Item	Specifications		
	GT1155-QTBD	GT1155-QSBD	GT1150-QLBD
Input power supply voltage	24VDC (+10% -15%), ripple voltage 200mV or less		
Fuse (built-in, not exchangeable)	1.0A		
Power consumption	9.84W (410mA/24VDC) or less		9.36W (390mA/24VDC) or less
At backlight off	4.32W (180mA/24VDC) or less		
Inrush current	15A or less (26.4V) 2ms		
Permissible instantaneous power failure time ¹	Within 5ms		
Noise immunity	Noise voltage: 1000Vp-p, Noise width: 1μs (by noise simulator of 30 to 100Hz noise frequency)		
Dielectric withstand voltage	500VAC for 1 minute (across power supply terminals and earth)		
Insulation resistance	10MΩ or larger by insulation resistance tester (across power supply terminals and earth)		
Applicable wire size	0.75 to 2[mm ²]		
Applicable solderless terminal	Solderless terminal for M3 screw RAV1.25-3, V2-N3A, FV2-N3A		
Applicable tightening torque (Terminal block terminal screw)	0.5 to 0.8[N·m]		

*1 The GOT continues to operate even upon 5ms or shorter instantaneous power failure. The GOT stops operating if there is extended power failure or voltage drop, while it automatically resumes operation as soon as the power is restored.

4.3 Mounting Position

When mounting the GOT, the clearances shown on the right must be left from a structure or the other device.

Installation Environment	A, D	B	C		E
			When the CF card is not used	When the CF card is used	
In the presence of radiated-noise or heat-generating equipment nearby	50 mm (1.97") or more	80 mm (3.14") or more ¹	50 mm (1.97") or more ²	100 mm (3.93") or more	100 mm (3.93") or more
In the absence of radiated-noise or heat-generating equipment nearby	20 mm (0.79") or more	20 mm (0.79") or more	20 mm (0.79") or more	20 mm (0.79") or more	20 mm (0.79") or more

*1 Vertical format...50 mm (1.97") or more (20 mm (0.79") or more)
*2 Horizontal format...80 mm (3.14") or more (20 mm (0.79") or more)

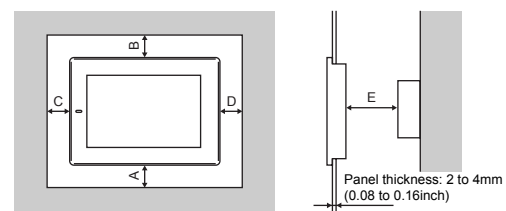

4.4 Control Panel Inside Temperature and Mounting Angle

When mounting the main unit to a control panel or similar, set the display section as shown below. When the temperature inside the control panel is 40 to 55°C (Horizontal mount), 40 to 50°C (Vertical mount), the mounting angle should be in the range 60° to 105° degrees.

- The GOT will be deteriorated earlier if it is used at the mounting angle other than the above. Therefore, the temperature inside the control panel should be within 40°C.

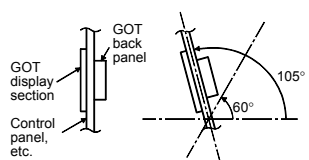

4.5 Installation Procedure

The GOT is designed to be embedded into a panel. Mount the GOT by following the procedure below. For panel cutting dimensions, refer to Section 4.2. Note that the panel thickness should be within 5mm.

1) Installing the packing

Install packing to the packing installation groove on the back panel of the GOT. While referring to the cross sectional view of the packing shown right, push the thinner side into the packing groove. (Right drawing is the example of lateral format.)

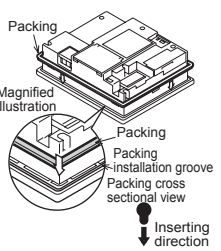

2) Inserting into the panel face

Insert the GOT from the front side of the panel.

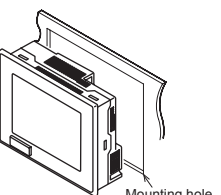

5. Wiring

3) Fixing the GOT
Engage the hook of the mounting fitting (accessory) to the unit fixing hole of the GOT and tighten the screw until the GOT is fixed with the mounting bolt (accessory). The GOT will be fixed in 4 upper/lower parts. Tighten the mounting screw with the specified torque. (Failure to do so may distort the panel and make a surface waviness on the protective sheet.)

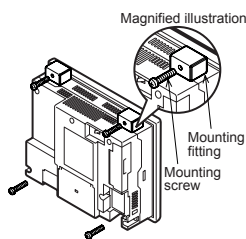

4) A protection film is attached on the display section of GOT prior to shipment. Remove the film when the installation is completed.

5.1 Power Supply Wiring

Connect the power supply to the power terminals on the back panel of the GOT. Use 0.75mm² or thicker cables to avoid voltage drop and tighten the terminal screw with the specified torque securely.

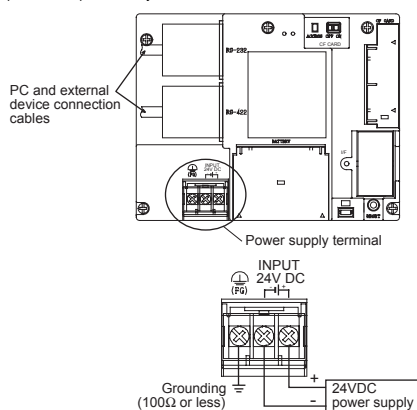

- Carry out the independent grounding if possible.
- If the independent grounding is impossible, carry out the shared grounding as shown in fig.2) below.
- Use the cable of 2mm² or more for grounding. Set the grounding point closer to the GOT to make the grounding cable short as possible.

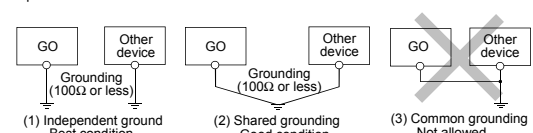

1) Recommended terminal shape

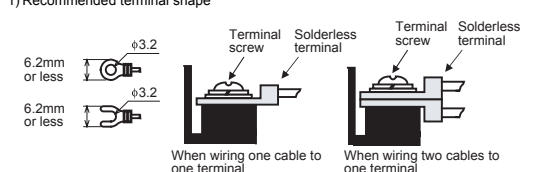

Applicable solderless terminal RAV 1.25-3, V2-N3A and FV2-N3A

6. Maintenance and Inspection

The GOT does not include consumable components that will cause the shorten life. However, note that battery life is 5 years and LCD life is 50,000 hours. The life of backlight in GT1155-QTBD, GT1155-QSBD is 75,000 hours and that in GT1150-QLBD is 54,000 hours. It is recommended to replace the battery periodically. (For the replacement of the liquid crystal screen and backlight, please consult your nearest sales office or FA Center.)

3.4 External Dimensions

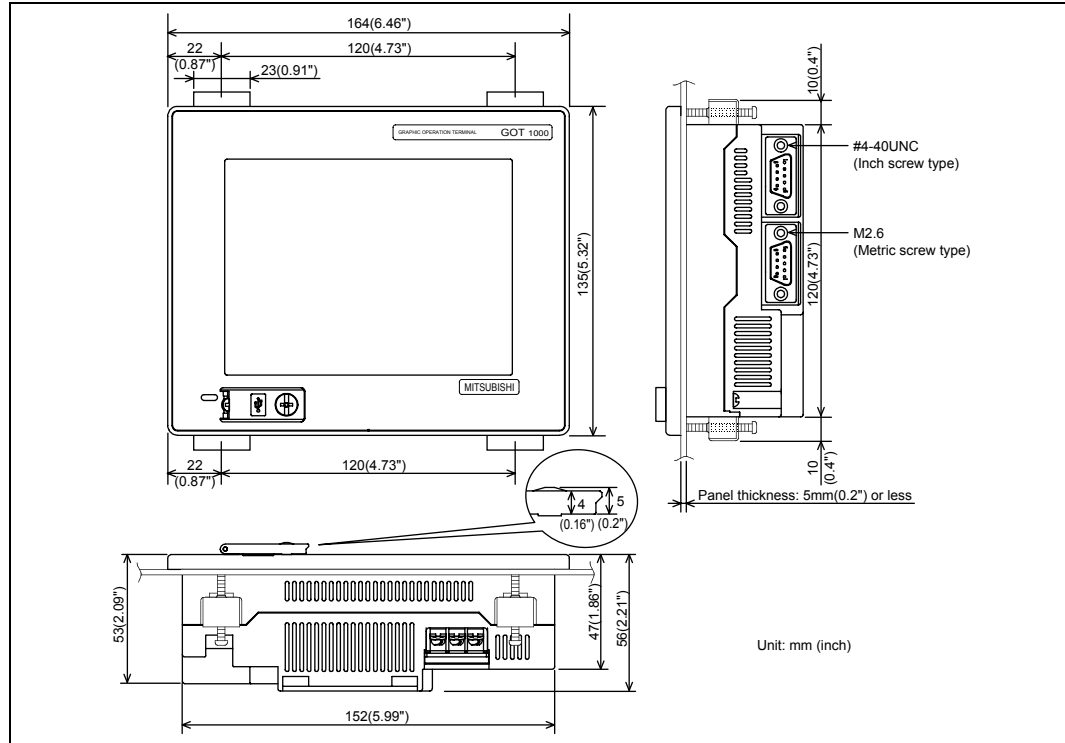

4. Installation

4.1 Control Panel Inside Dimensions for Mounting GOT

Mount the GOT onto the control panel while considering the following control panel inside dimensions.

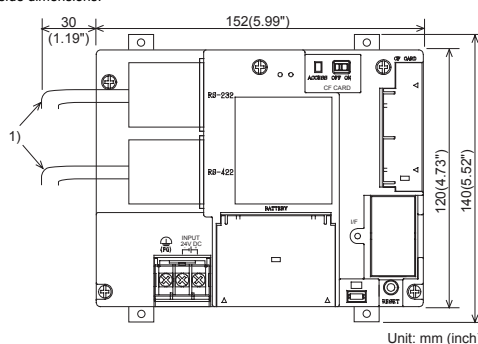

No	Name
1)	PLC connection cable/PC connection cable

Applicable cable

Some cables may need to be longer than the specified dimensions when connecting to the GOT. Therefore, consider the connector dimensions and bending radius of the cable as well for installation.

4.2 Panel Cutting Dimensions

Make holes in the panel according to the dimensions list below. Also, ensure 10mm spaces in upper and lower parts of the panel for mounting fixtures.

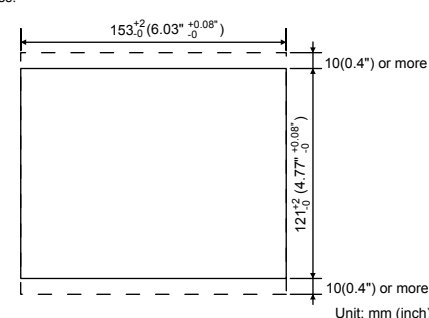

6.1 Daily Inspection

Daily inspection items

No.	Inspection Item	Inspection Method	Criterion	Action	
1	GOT mounting status	Check for loose mounting screws.	Securely mounted	Retighten screws within the specified torque range	
2	Connection status	Loose terminal screws	Retighten screws with screwdriver	Not loose	Retighten terminal screws
		Proximate solderless terminals	Visual check	Proper intervals	Correct
3	Usage status	Loose connectors	Visual check	Not loose	Retighten connector fixing screws
		Dirt on protection sheet	Visual check	Not outstanding	Replace with new one
	Foreign material attachment	Visual check	No foreign matter sticking	Remove clean	

Refer to the following for the model names of the protection sheet or the replacement procedure.
→ GT11 User's Manual

6.2 Periodic Inspection

Yearly or half-yearly inspection items
The following inspection should also be performed when equipment has been moved or modified or the wiring changed.

No.	Inspection Item	Inspection Method	Criterion	Action	
1	Surrounding environment	Ambient temperature Ambient humidity Atmosphere	Make measurement with thermometer or hygrometer Measure corrosive gas No corrosive gas	Display section 0 to 50°C Other portions 0 to 55°C 10 to 90%RH For use in control panel, temperature inside control panel is ambient temperature	
2	Power supply voltage check	24VDC Measure voltage across terminals.	20.4 to 26.4VDC	Change supply power	
3	Mounting status	Looseness Dirt, foreignmatter	Move module Visual check	Should be mounted firmly No dirt, foreign matter sticking	Retighten screws Remove, clean
4	Connection status	Loose terminal screws	Retighten screws with screwdriver	Not loose	Retighten terminal screws
		Proximate solderless terminals	Visual check	Proper intervals	Correct
	Loose connectors	Visual check	Not loose	Retighten connector fixing screws	
5	Battery	Check the system alarm (error code: 500) report on the Alarm information screen	(Preventive maintenance)	Replace with new battery when the current battery has reached the specified life span, even if battery voltage is not displayed.	

6.3 Battery Replacement

The battery is used for backing up the clock data, alarm history or recipe data. Screen data is stored in the flash memory and data is retained even if the battery is dead.

- Battery model name
GT11□□ is shipped with the following battery.

Product name	Model name
Battery	GT11-50BAT

Battery replacement procedure

- Turn the GOT power off.
- Open the back cover of the GOT.
- Remove the old battery from the holder.
- Disconnect the old battery connector and insert the new battery connector within 30s.
- Insert the new battery into the holder and close the back cover.
- Turn the GOT power on.
- Check if the battery condition is normal with the utility. Refer to the following for the details of battery status display.
→ GT11 User's Manual

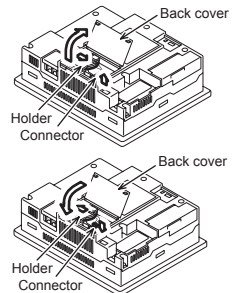

How to confirm production year and month

The production year and month of the battery built in the purchased GOT can be confirmed by the production No. (serial No.) marked on the GOT main unit.

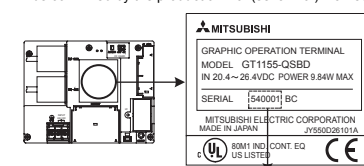

Year (example: 2005) last digit
Month (example: Jun.), 1 to 9: Jan. to Sep., X: Oct., Y: Nov., Z: Dec.

The production date of the battery built in the purchased GOT can be confirmed by the production No. (serial No.) marked on the GOT main unit.

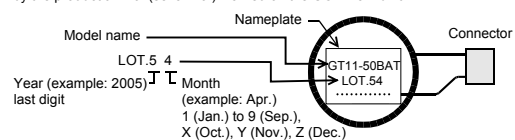

- Battery life
Approximate battery life: 5 years (ambient temperature: 25°C)
Battery replacement: In 4 to 5 years

Approximate life is 5 years, but life may be shorter depending on the ambient temperature, therefore, note that the battery must be replaced in 4 to 5 years. Make sure to purchase a new battery as needed as it self-discharges.

Battery status can be confirmed on a GOT utility screen. For details of battery status or how to output alarm, refer to the following:
→ GT11 User's Manual

This manual confers no industrial property rights or any rights of any other kind, nor does it confer any patent licenses. Mitsubishi Electric Corporation cannot be held responsible for any problems involving industrial property rights which may occur as a result of using the contents noted in this manual.

Warranty
Mitsubishi will not be held liable for damage caused by factors found not to be the cause of Mitsubishi; opportunity loss or lost profits caused by faults in the Mitsubishi products; damage, secondary damage, accident compensation caused by special factors unpredictable by Mitsubishi; damages to products other than Mitsubishi products; and to other duties.

For safe use

- This product has been manufactured as a general-purpose part for general industries, and has not been designed or manufactured to be incorporated in a device or system used in purposes related to human life.
- Before using the product for special purposes such as nuclear power, electric power, aerospace, medicine or passenger movement vehicles, consult with Mitsubishi Electric.
- This product has been manufactured under strict quality control. However when installing the product where major accidents or losses could occur if the product fails, install appropriate backup or failsafe functions in the system.